

BRITISH WWII FIGHTER 1:144 SCALE PLASTIC KIT

DUAL COMBO!



eduard

ATTENTION * UPOZORNĚNÍ * ACHTUNG * ATTENTION * 注意



Carefully read instruction sheet before assembling. When you use glue or paint, do not use near open flame and use in well ventilated room. Keep out of reach of small children. Children must not be allowed to suck any part, or pull vinyl bag over the head.



Před započítím stavby si pečlivě prostudujte stavební návod. Při používání barev a lepidla pracujte v dobře větrané místnosti. Lepidla ani barvy nepoužívejte v blízkosti otevřeného ohně. Model není určen malým dětem, mohlo by dojít k požití drobných dílů.

INSTRUCTION SIGNS * INSTR. SYMBOLY * INSTRUKTION SINNBILDEN * SYMBOLES * 記号の説明



OPTIONAL
VOLBA



BEND
OHNOUT



OPEN HOLE
VYVRTAT OTVOR



SYMETRICAL ASSEMBLY
SYMETRICKÁ MONTÁŽ



NOTCH
ZÁREZ



REMOVE
ODRÍZNOUT



APPLY EDUARD MASK AND PAINT
POUŽIT EDUARDS MASK NABARVIT

PARTS * DÍLY * TEILE * PIÈCES * 部品

PLASTIC PARTS

A> 2 pcs.

4428 A

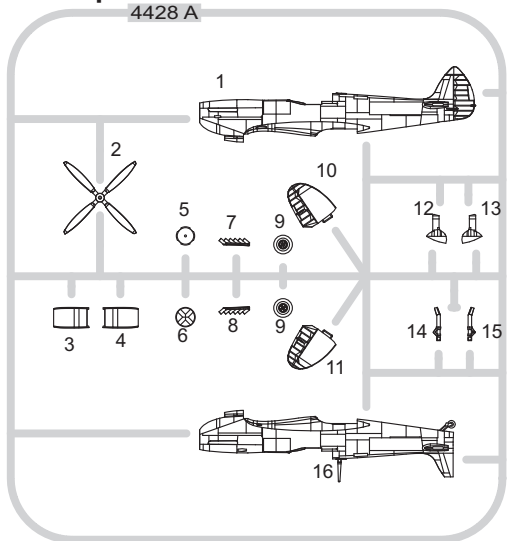

CLEAR PART

2 pcs.

C>

4428 C

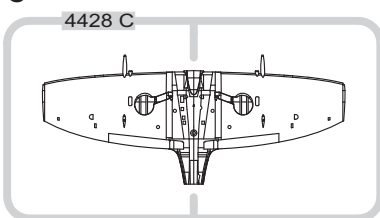

D>

4428 D

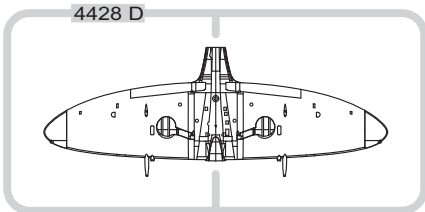

COLOURS * BARVY * FARBEN * PEINTURE * 色

GSI Creos (GUNZE)

AQUEOUS	Mr.COLOR	
H14	C4	YELLOW
H12	C33	FLAT BLACK
H13	C3	RED
H33	C81	RUSSET
H74	C26	SKY
H77	C137	TIRE BLACK

AQUEOUS	Mr.COLOR	
H309	C309	GREEN
H310	C316	WHITE
H330	C330	DARK GREEN
H331	C331	DARK SEAGRAY
H332	C332	LIGHT GRAY
H80	C54	KHAKI GREEN

Mr.COLOR SUPER METALLIC	
SM04	SUPER STAINLESS
SM06	CHROME SILVER
Mr.METAL COLOR	
MC218	ALUMINIUM

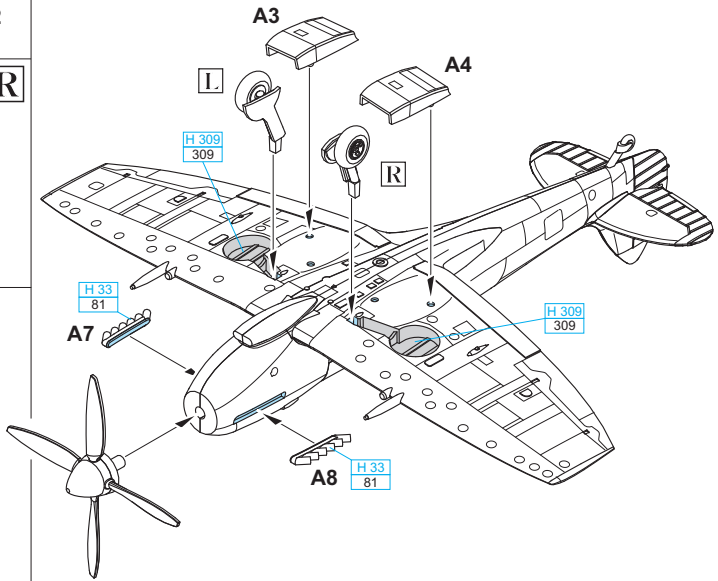
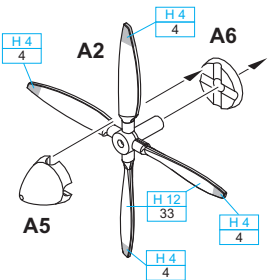
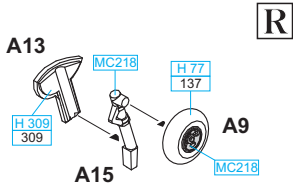
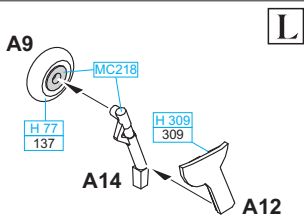
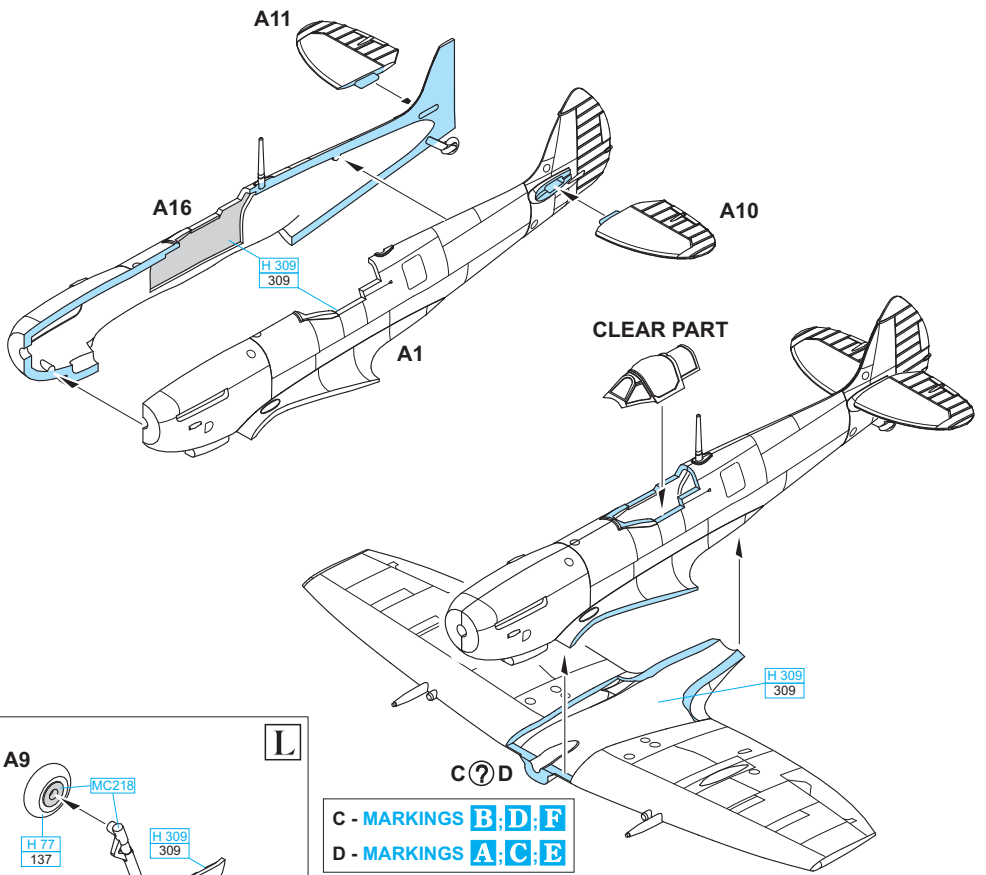

A Spitfire Mk.IXe, PT396, flown by W/C Jack Charles, Tangmere Wing, Tangmere AB, March, 1945

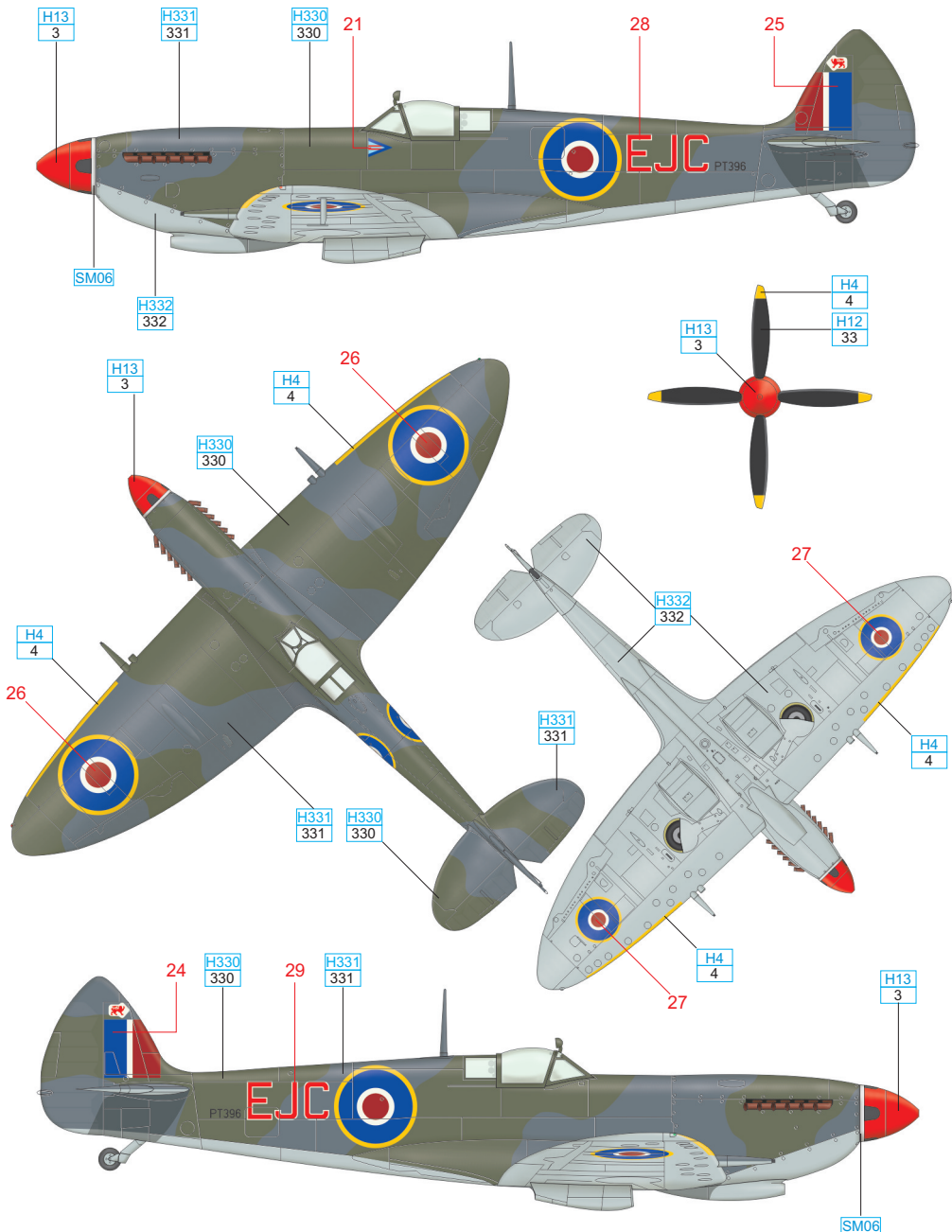

SILVER	SM06	YELLOW	H4 4	RED	H13 3
WHITE	H316 316	FS 36270	H332 332	FS 36152	H331 331
				FS 34079	H330 330
				BLACK	H12 33

B Spitfire LF Mk.IXe, TE 515, Czechoslovak Air Force, former No. 312 Squadron RAF, Ceske Budejovice AB, August 22, 1945

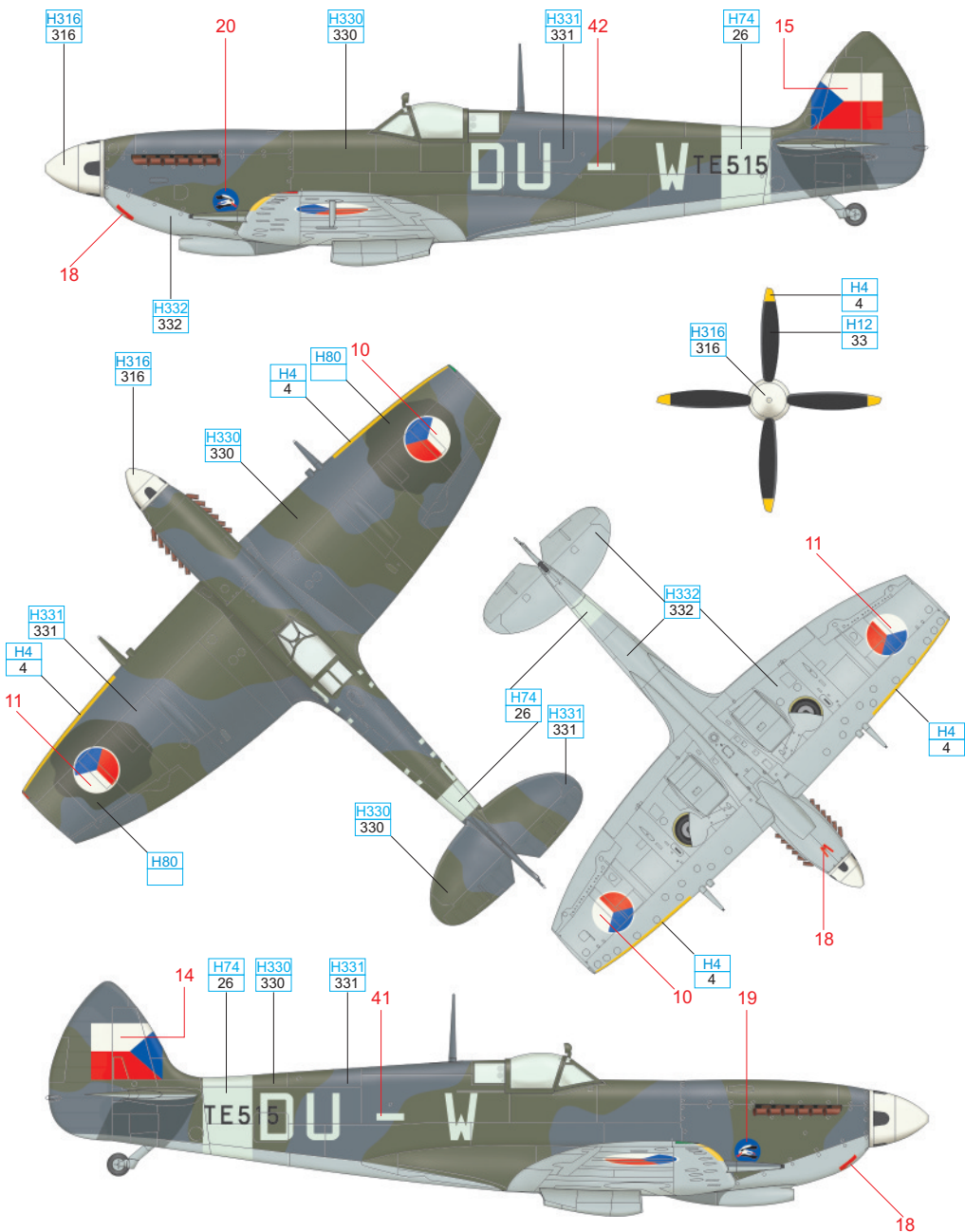

WHITE	H316 316	YELLOW	H4 4									
FS 35622	H74 26	FS 36270	H332 332	FS 36152	H331 331	FS 34079	H330 330	DARK GREEN	H80 54	BLACK	H12 33	eduard

C Spitfire Mk.IXe, PV 181, flown by W/C Rolf Arne Berg,
No. 132 (Norwegian) Wing, Twente AB, the Netherlands, winter, 1944 - 1945

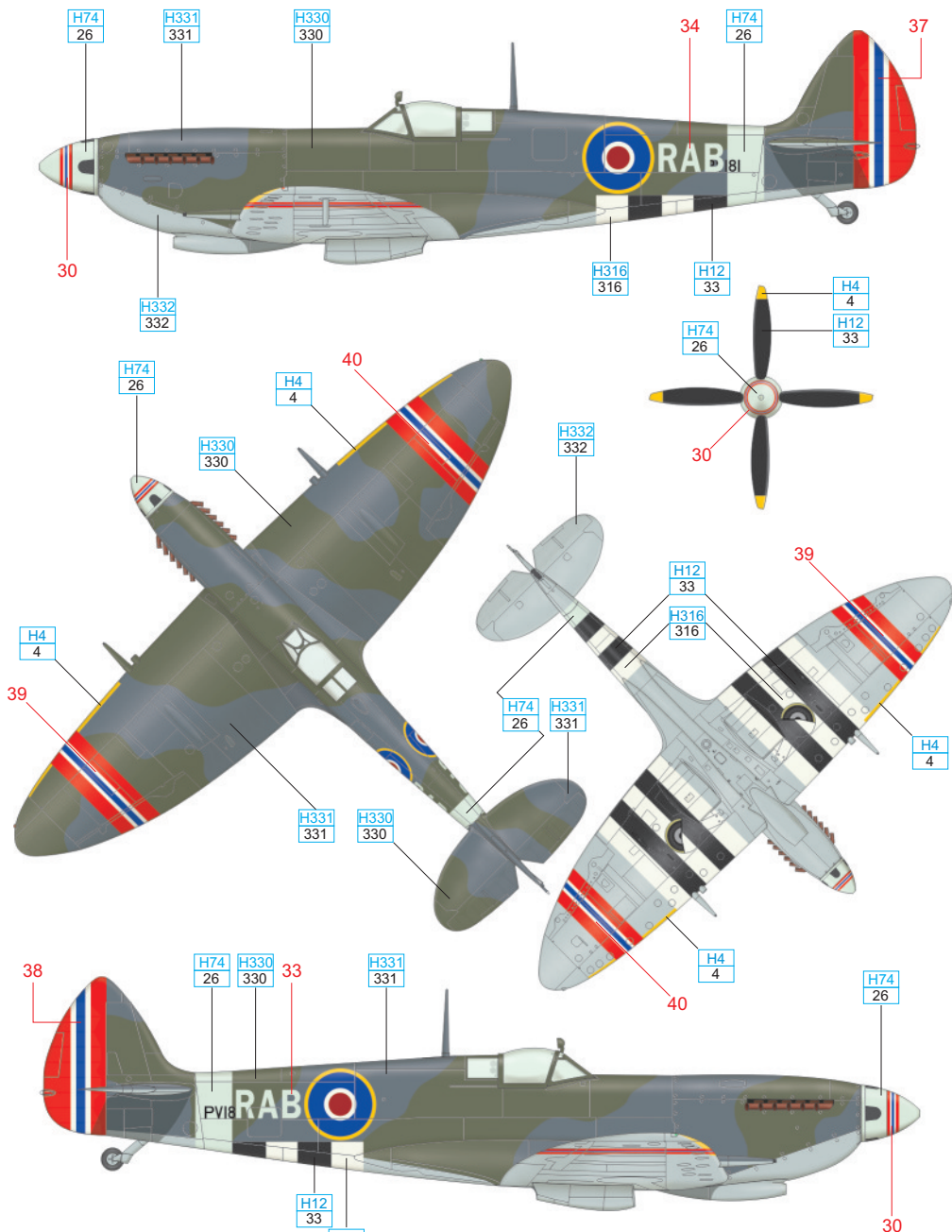

WHITE	H316 316	YELLOW	H4 4						
FS 35622	H74 26	FS 36270	H332 332	FS 36152	H331 331	FS 34079	H330 330	BLACK	H12 33

D Spitfire Mk.IXe, MK 791, French Air Force, GC I/4, French Indochina, ca 1947 – 1948

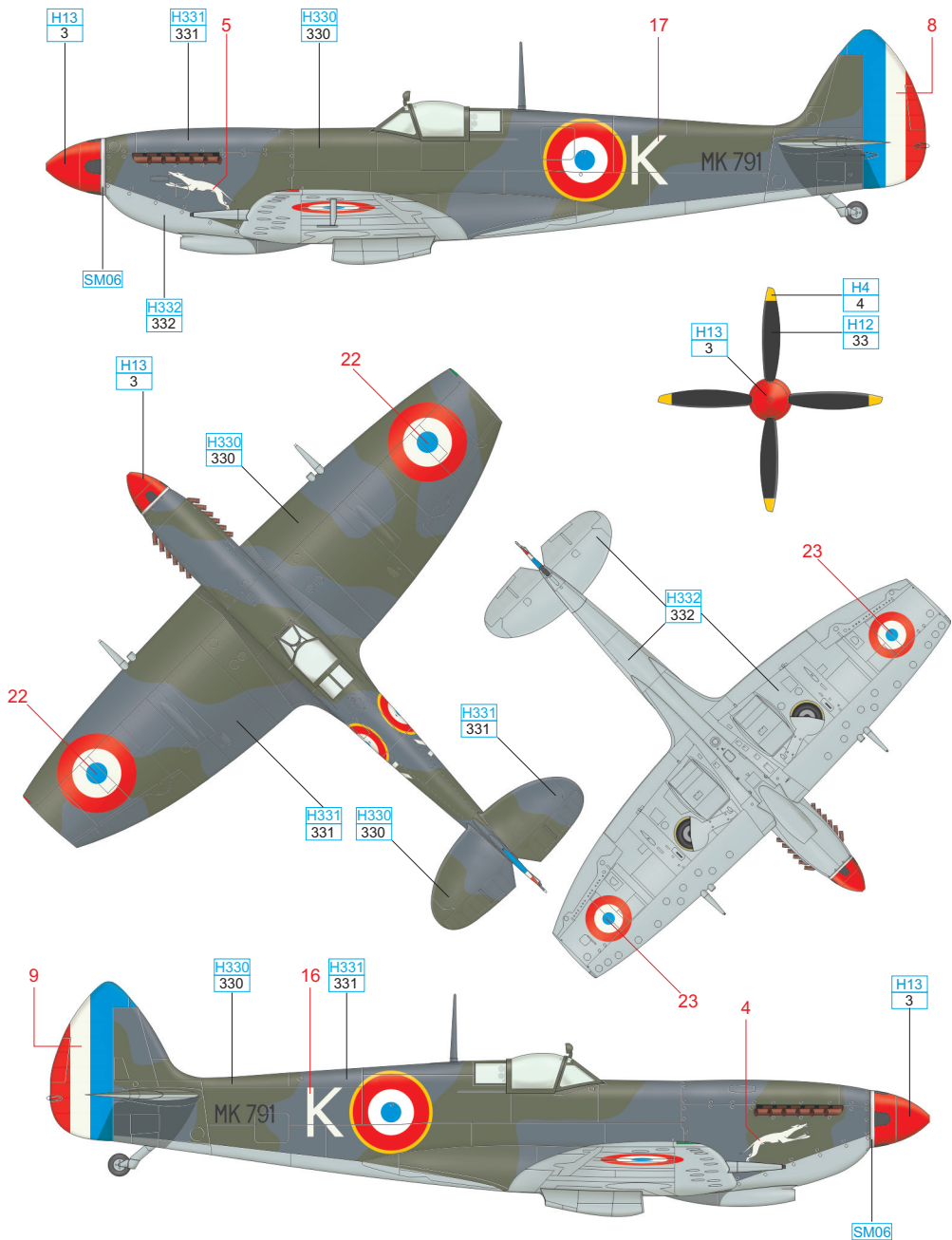

SILVER	SM06	RED	H13 3
YELLOW	H4 4	FS 36270	H332 332
		FS 36152	H331 331
		FS 34079	H330 330
		BLACK	H12 33

E Spitfire LF Mk.IXe, No. 105 Squadron of Israeli Air Force, Ramat David AB, June, 1953

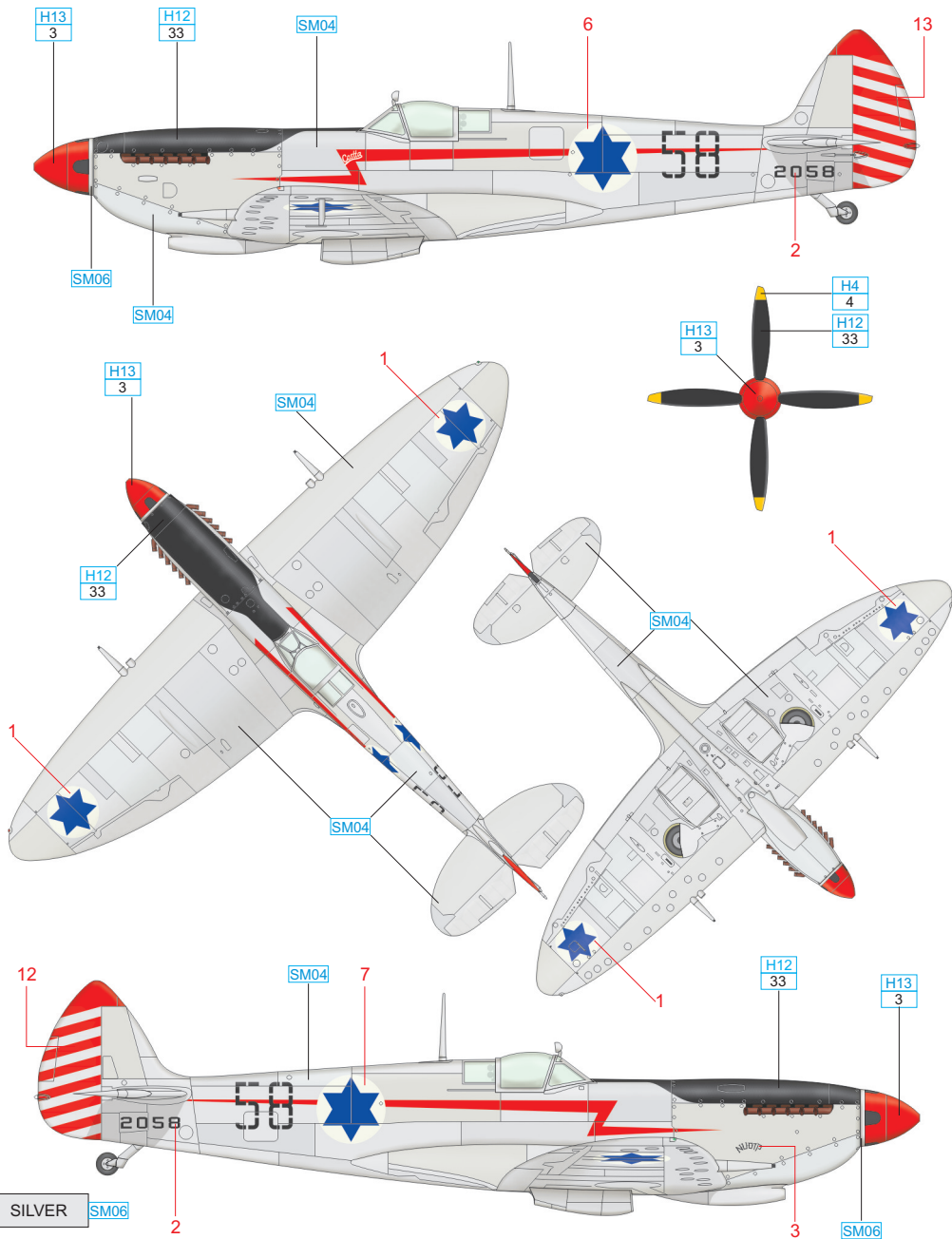

SILVER SM06

STAINLES SM04

YELLOW H4 4

RED H13 3

BLACK H12 33

F Spitfire Mk.IXe, TD 147, flown by W/C James „Sticky“ Edwards, Schneverdingen AB, Germany, May, 1945

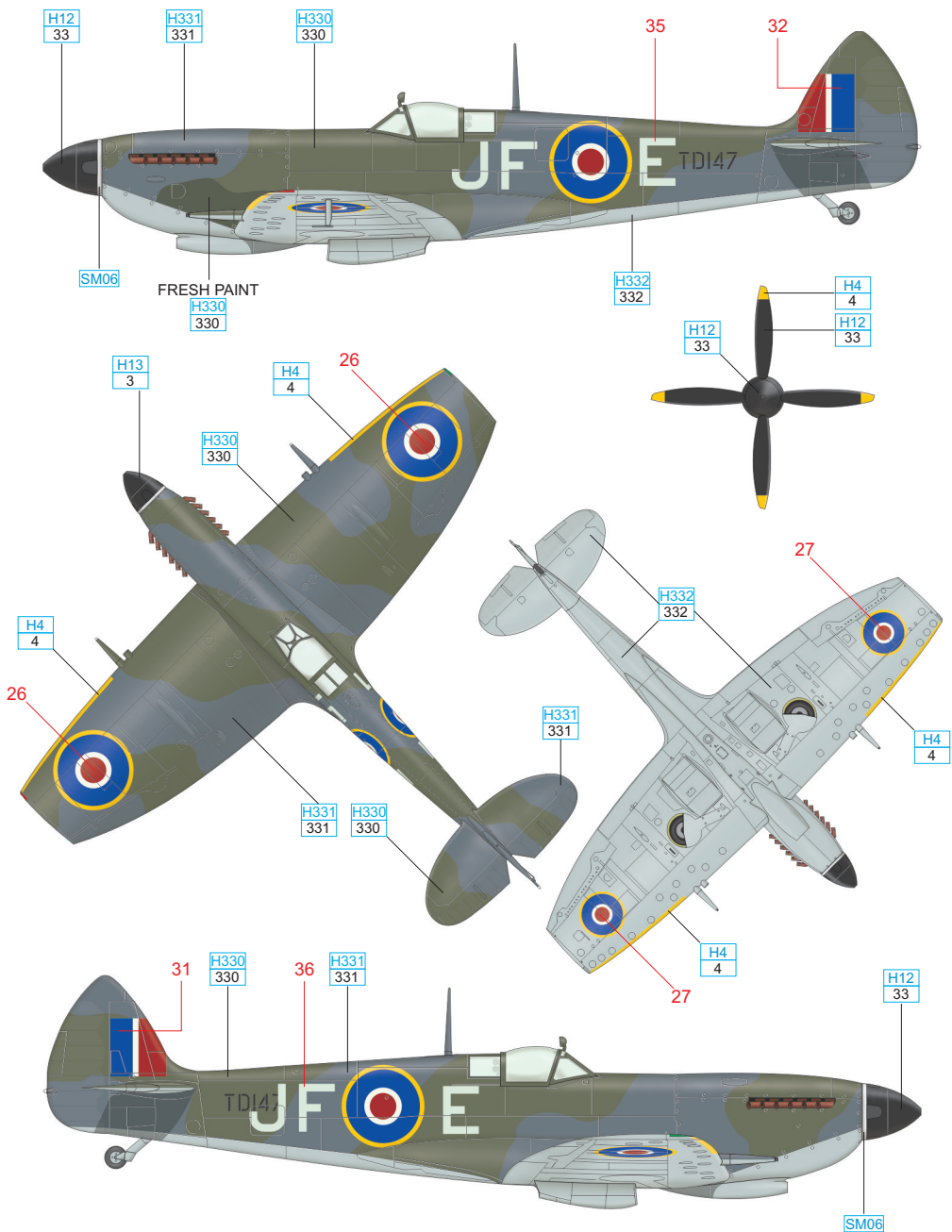

SILVER	SM06						
YELLOW	H4 4	FS 36270	H332 332	FS 36152	H331 331	FS 34079	H330 330
						BLACK	H12 33

eduard