



# 672 082 Fw 190A-8 engine

for Eduard kit - pro stavebnici Eduard



## 1/72 scale



R24 R25 R26 R35

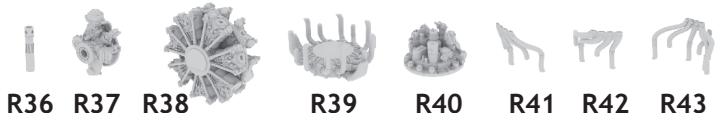

R36 R37 R38 R39 R40 R41 R42 R43



R44 R45 R46 R47 R48 R49 R50

### COLOURS

GSI Creos (GUNZE)			Mr.METAL COLOR	
AQUEOUS	Mr.COLOR		Mr.COLOR	
<a href="#">H 7</a>	<a href="#">C 7</a>	BROWN	<a href="#">MC214</a>	DARK IRON
<a href="#">H 12</a>	<a href="#">C 33</a>	FLAT BLACK	<a href="#">MC218</a>	ALUMINIUM
<a href="#">H 33</a>	<a href="#">C 81</a>	RUSSET		
	<a href="#">C 45</a>	SAIL COLOR		
<a href="#">H 70</a>	<a href="#">C 60</a>	GRAY RLM02		

This product contains metal and resin detail parts for upgrading scale plastic models. When selecting this set make sure that it is for the kit mentioned in product name as these sets are made specifically for that kit. When upgrading the model some cutting or corrections may be necessary for parts to fit accurately. **WARNING!** This set contains small and sharp parts. Work carefully in a ventilated and well-lit room. Safety glasses are recommended. This product is not suitable for children below 14 years of age.

Tento výrobek obsahuje leptané a odlévané detaily pro úpravu a vylepšení plastického modelu. Při výběru sady kovových detailů zkontrolujte, zda je určena pro model, který chcete upravit. Model, pro který je sada určena, je uveden v názvu výrobku. Pro přesnou aplikaci kovových a odlévaných dílů může být zapotřebí upravit díly upravovaného modelu. **POZOR!** Sada obsahuje malé ostré díly. Pracujte ve větrané a dobře osvětlené místnosti. Doporučujeme použití ochranných brýlí. Tento výrobek není vhodný pro děti mladší 14 let.



435 21 Obrnice 170  
Czech Republic

[www.eduard.com](http://www.eduard.com)









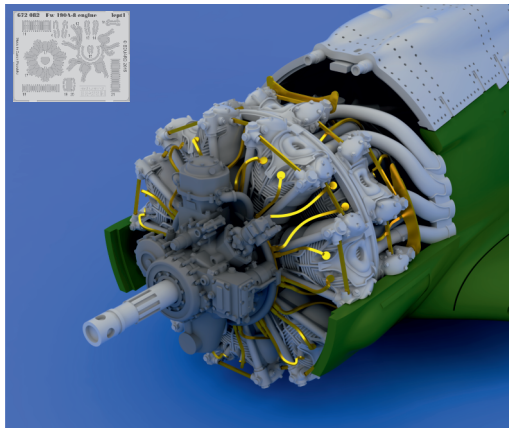

# 672 082 Fw 190A-8 engine

for Eduard kit - pro stavebnici Eduard

# 1/72



## BEST BRASS RESIN AROUND!

-  REMOVE  
ODSTRANIT
- BEND  
OHNOUIT
-  GRIND  
OBROUSIT
-  OPTION  
VOLBA
-  DRILL HOLE  
VRTAT OTVOR
-  REPLACE  
NAHRADIT
-  SYMMETRICAL ASSEMBLY  
SYMETRICKÁ MONTÁŽ
-  SCRIBE THE PANEL AND HOLES  
RYTI
-  REVERSE SIDE  
OTOČIT

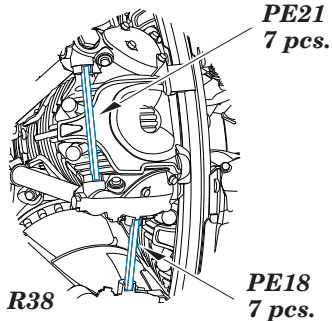

**2**

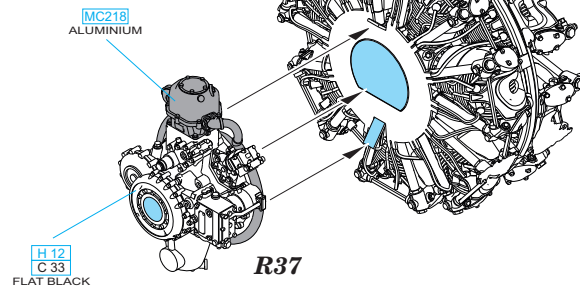

**3**

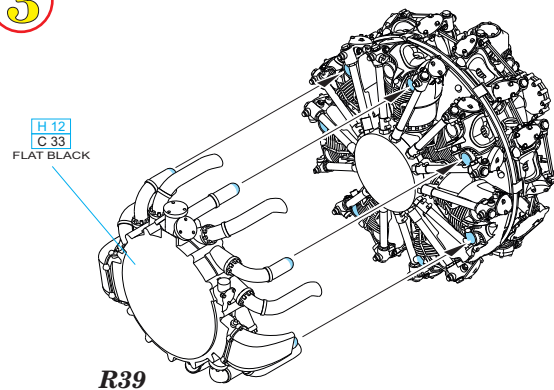
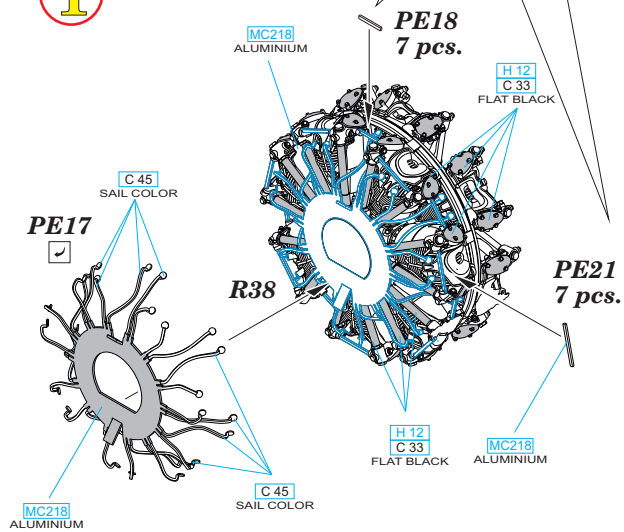

4

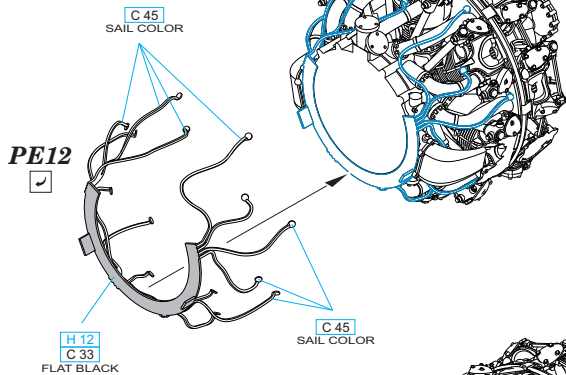

5

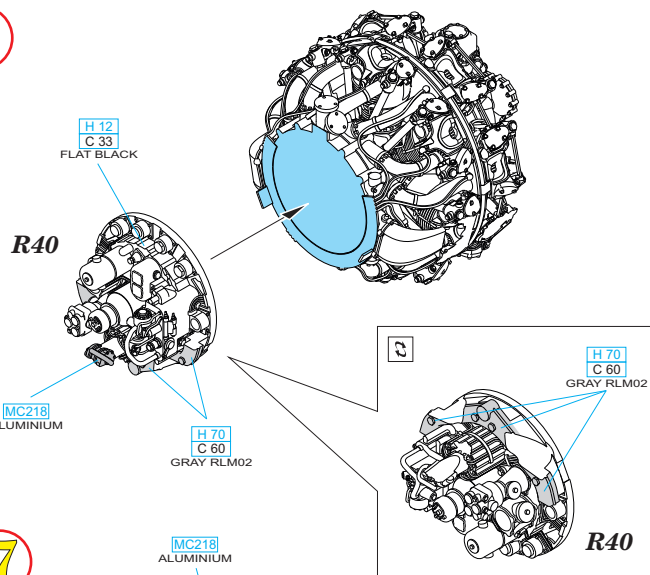

6

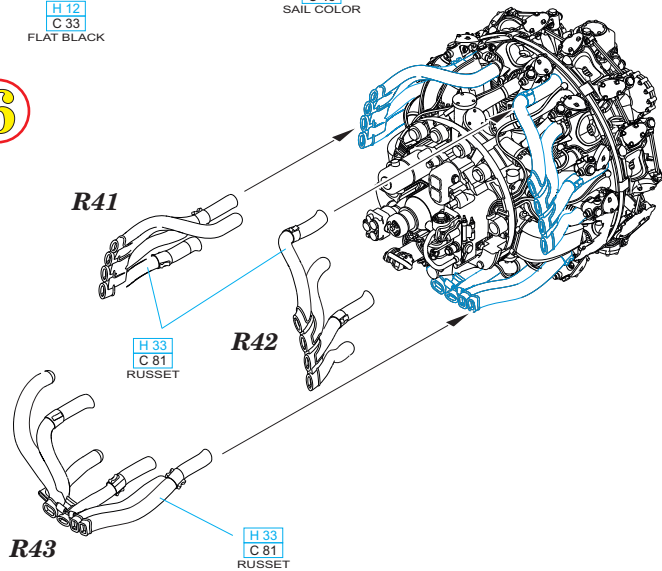

7

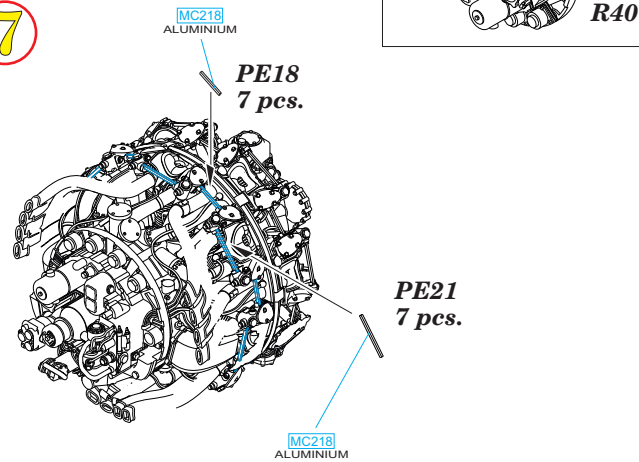

8

use PE16 if R46 is not used only

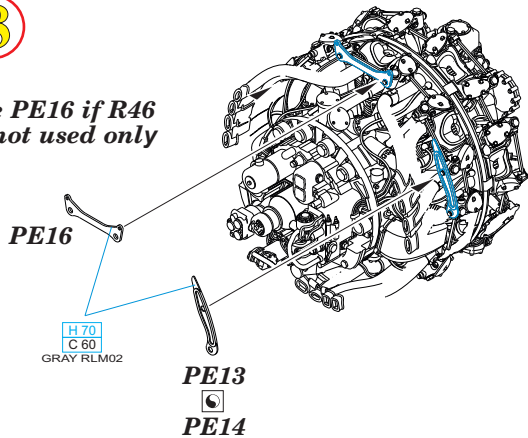

9

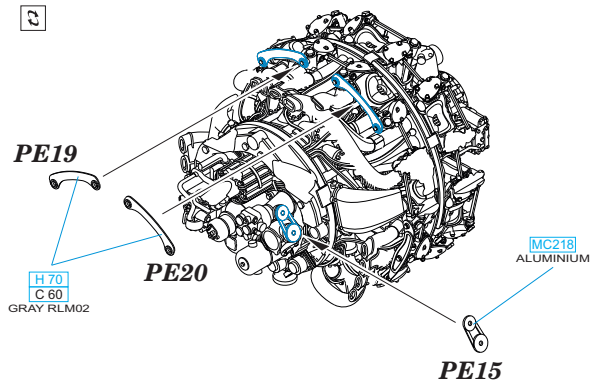

10

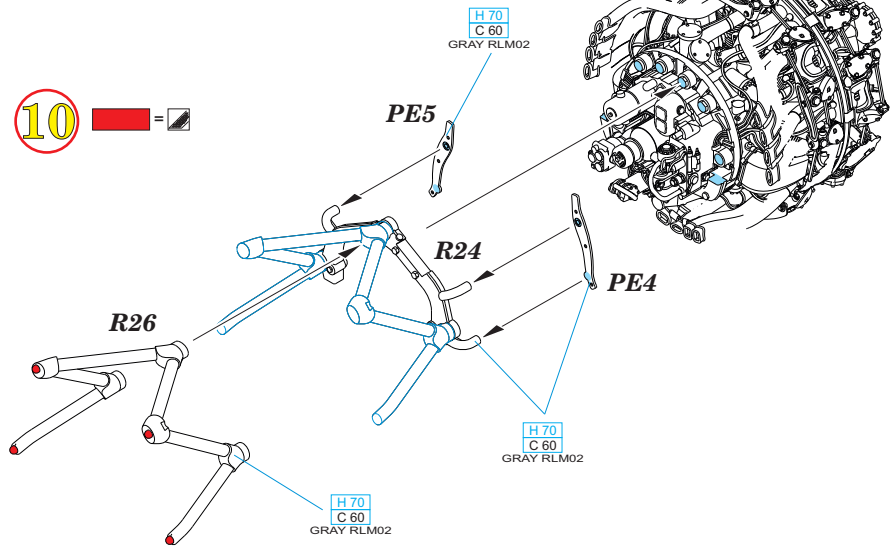

11

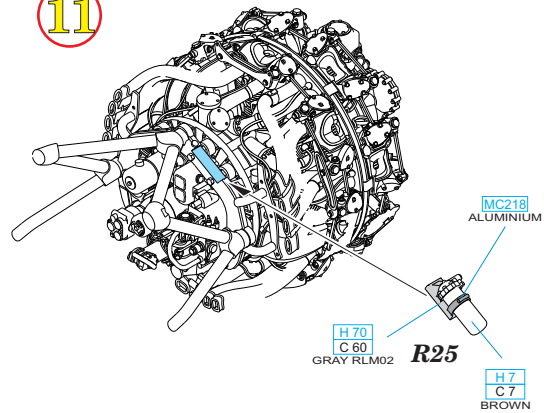



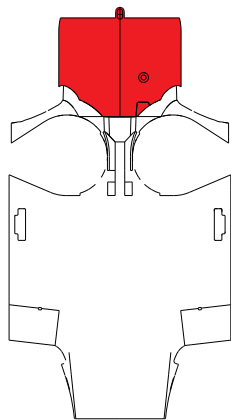

*plastic C14*

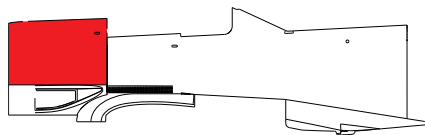

*plastic C1*

 *plastic C2*

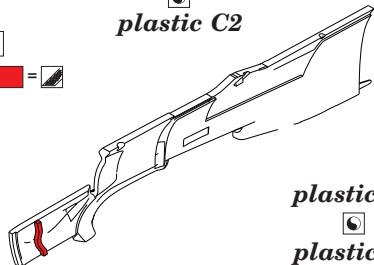

*plastic C2*

 *plastic C1*

12

*R50*

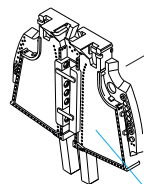

H 70  
C 60  
GRAY RLM02

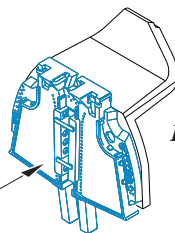

*plastic A80*

13

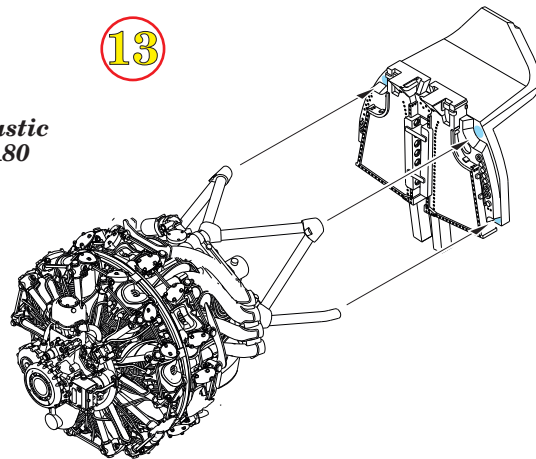

14

*plastic C2*

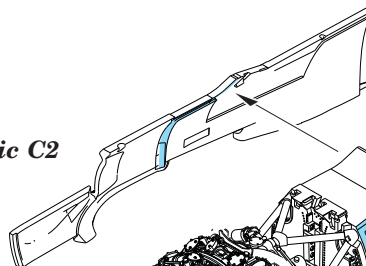

*plastic C1*

