

eduard
MASK

A-37A/B Dragonfly 1/48

The die-cut mask for accurate canopy frame painting of the
Revell/Monogram 1/48 KIT

EX 138

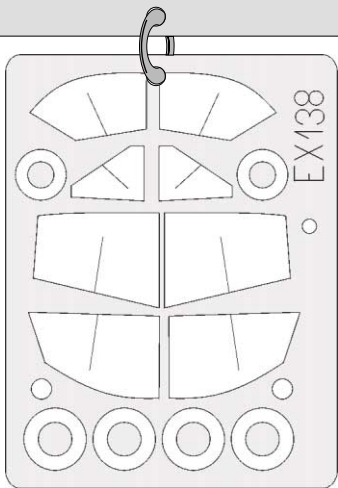

1.)

80

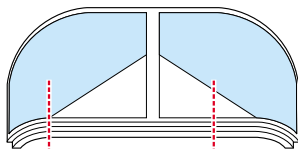

2.)

80

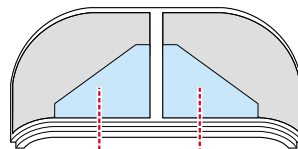

3.)

27

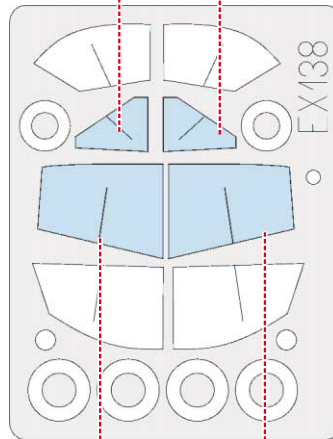
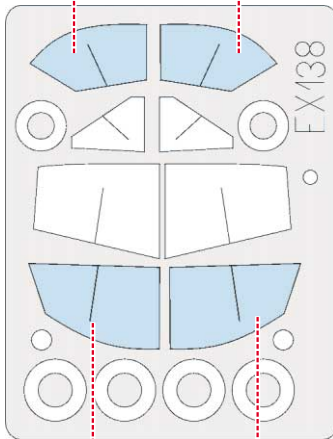
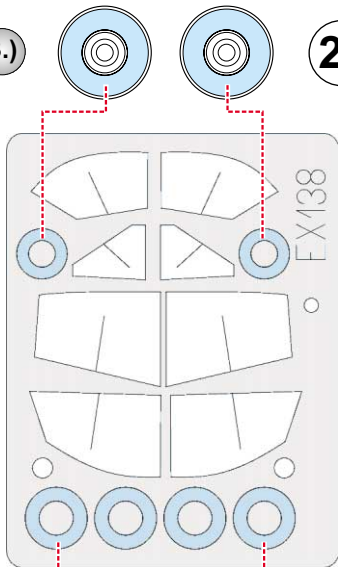

81

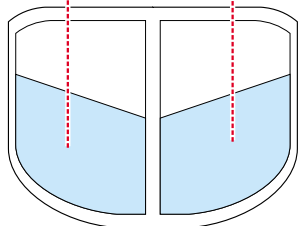

81

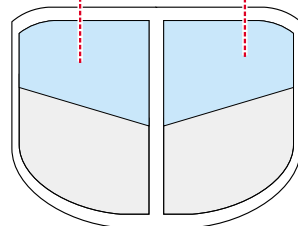

4.)

36

2x

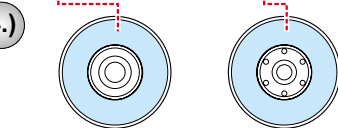

83

36

6.)

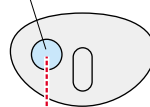

5.)

84

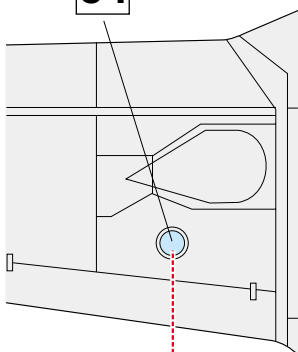

84

